

# Handleiding ballonboom

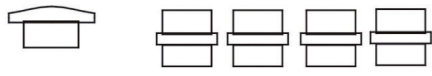

Tussenringen

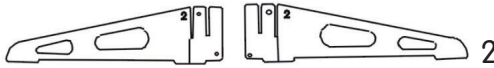
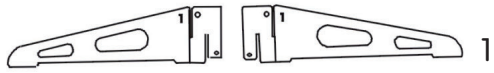

Bodemstandaard

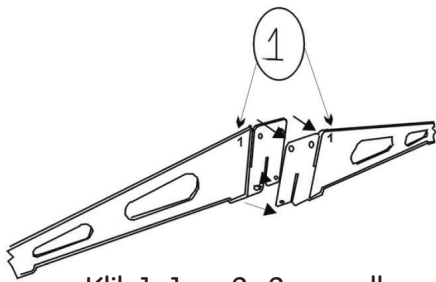

Klik 1+1 en 2+2 aan elkaar

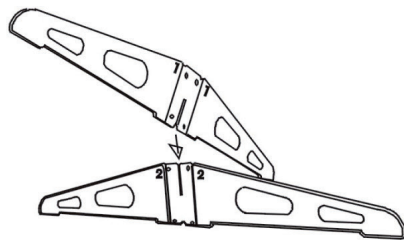
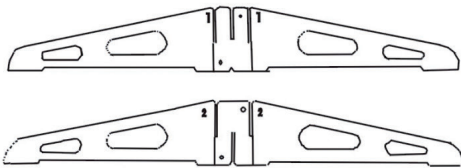

Schuif 1 en 2 in elkaar

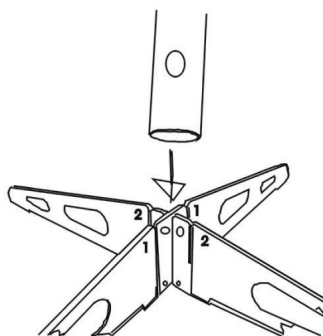

Plaats de tubes met tussenringen op de bodemstandaard

